

Data Sheet



Article number: 025848660048

Description: Norma Connect pipe coupling
COMBI GRIP GL W5 Ø48,3/50 NBR 16 bar

Measures

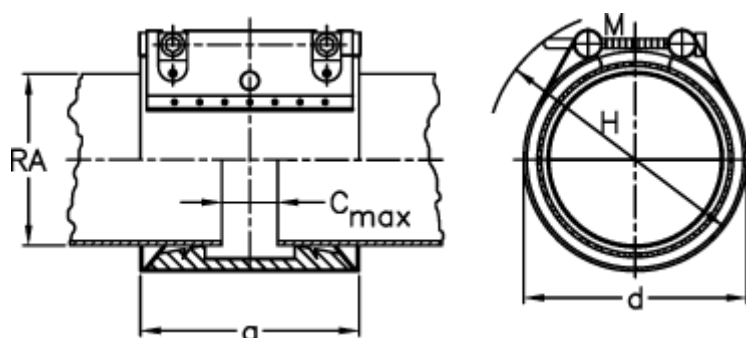

a	= 62.4	RA min-RA max plastic = 49,5-50,5
C max with insertion band	= 8	Weight a piece = 0.6
d	= 70	
H	= 90	
M (screw)	= M8	
Nominal pressure (bar)	= 16	
RA	= 48,3/50,0	
RA min-RA max metal	= 47,8-49,0	